

Integración de frenada



Julen Galera

Introducción

- Sensores de velocidad



- Actuador



- Sistema hidráulico

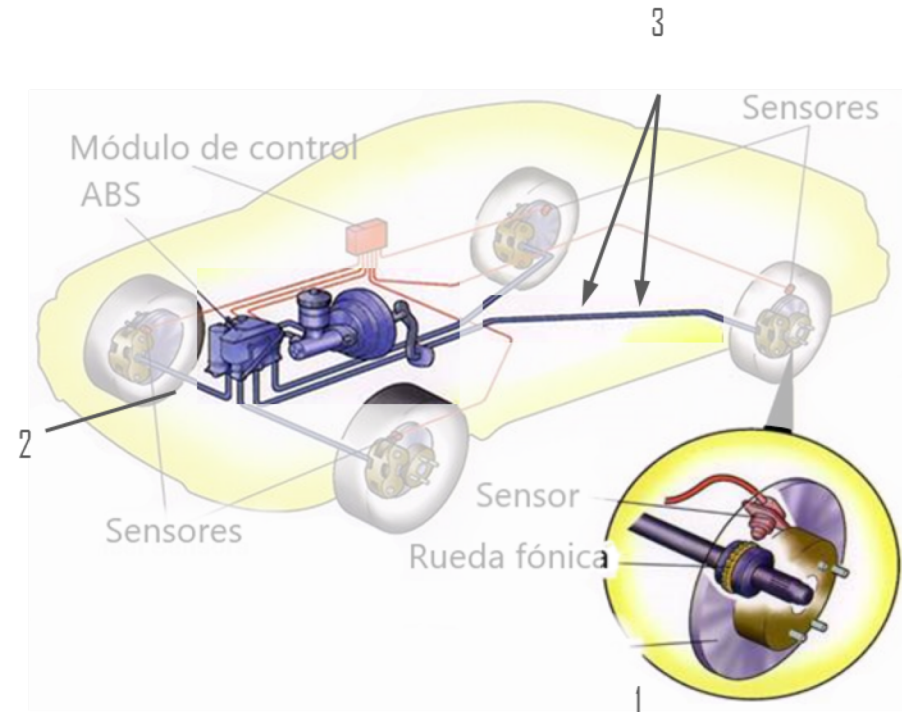

Instalación de sensores de velocidad

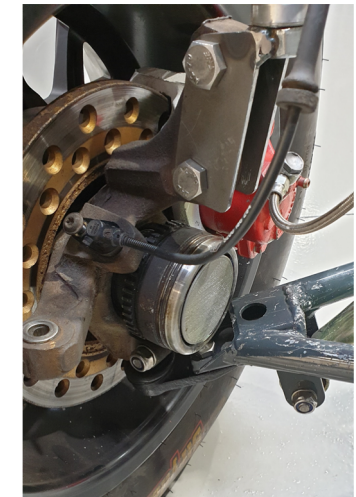
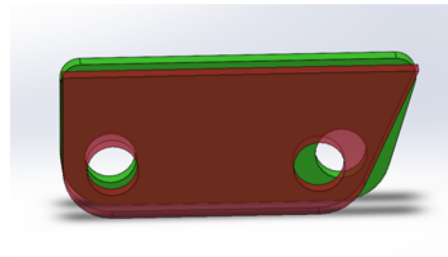
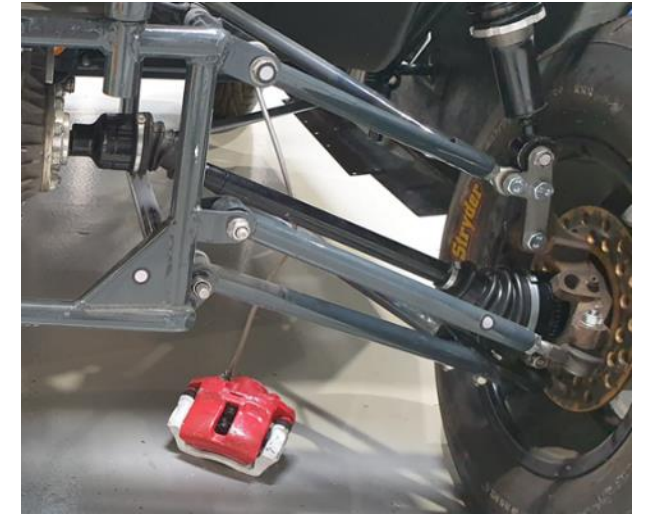
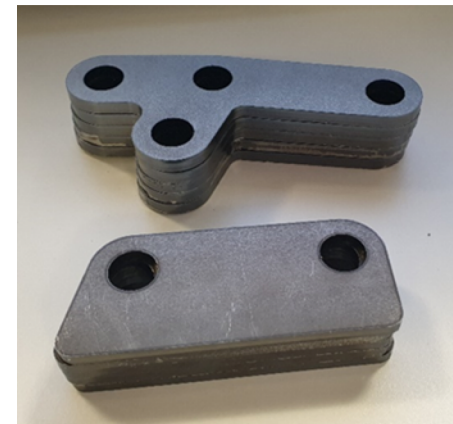
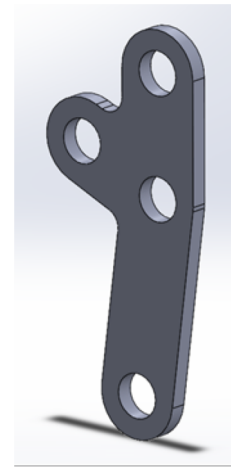
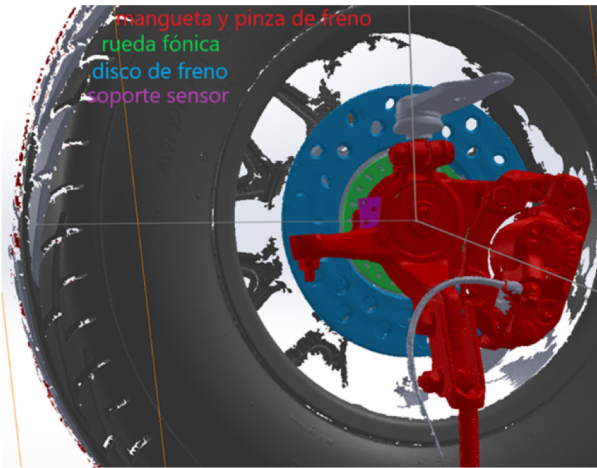

Conceptualización

Diseño

Fabricación

Montaje

Instalación de actuador

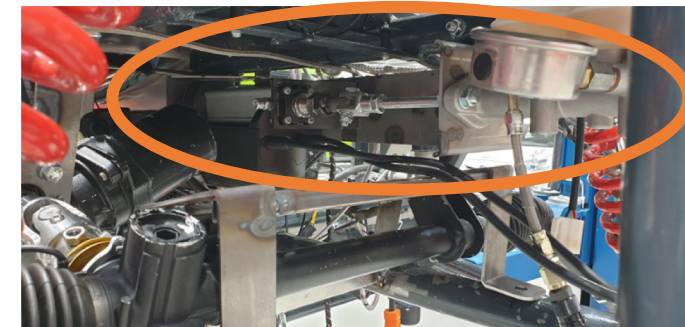
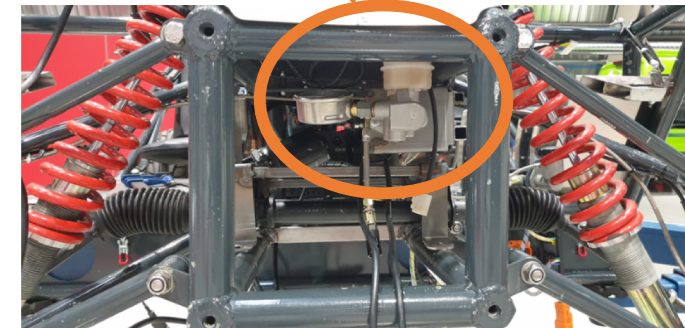
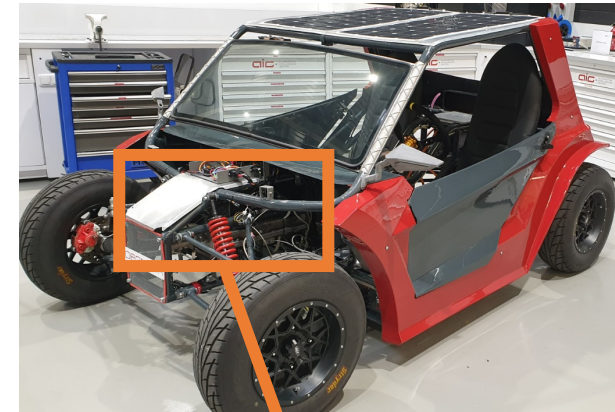
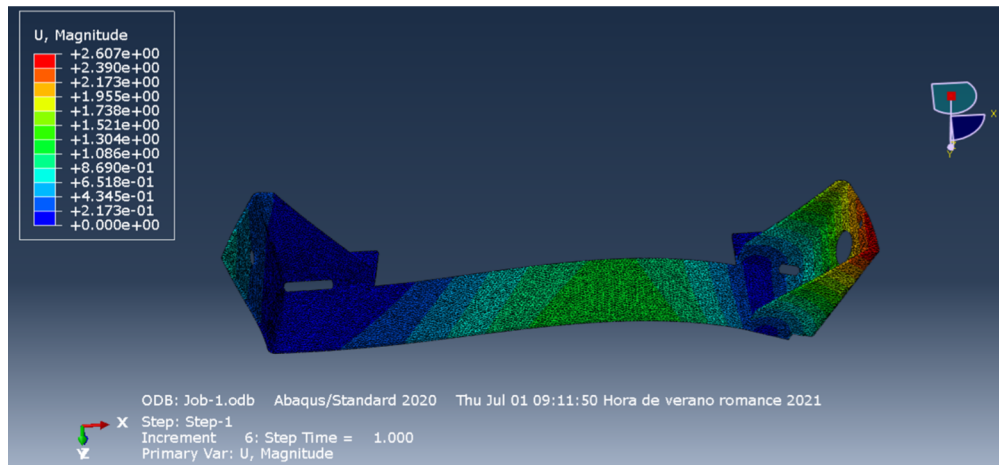
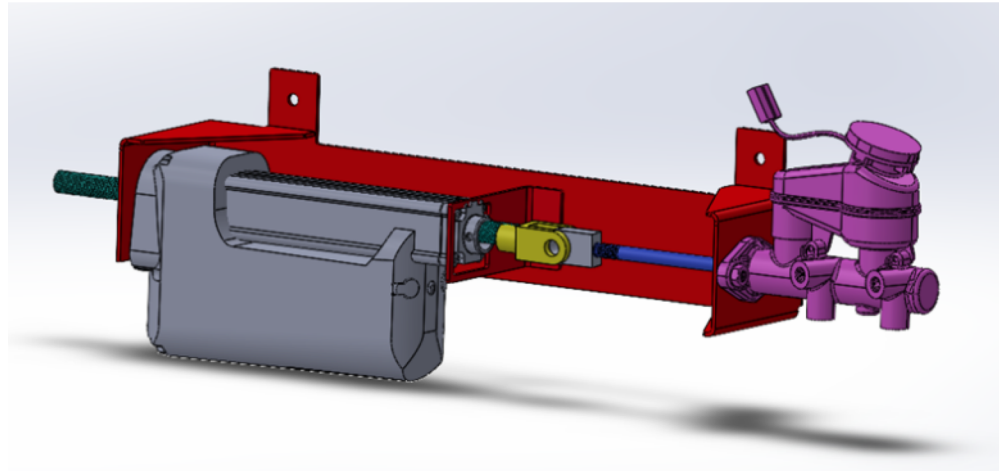

Configuración de sistema hidráulico

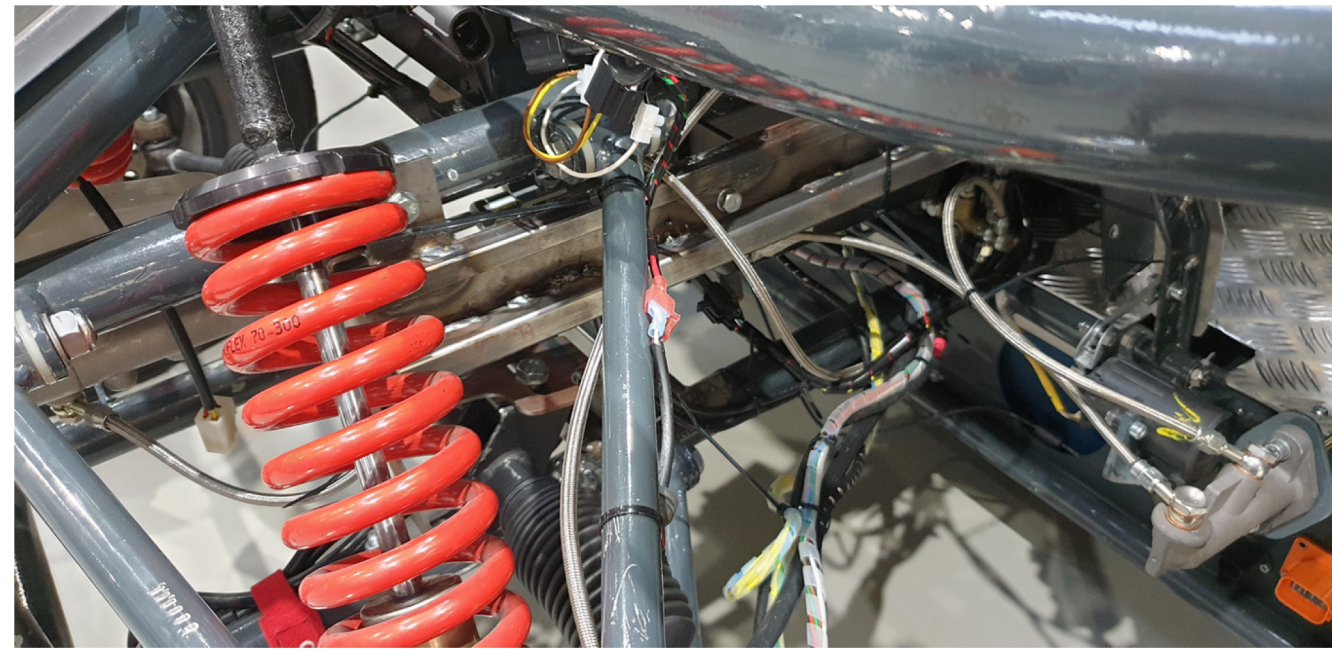
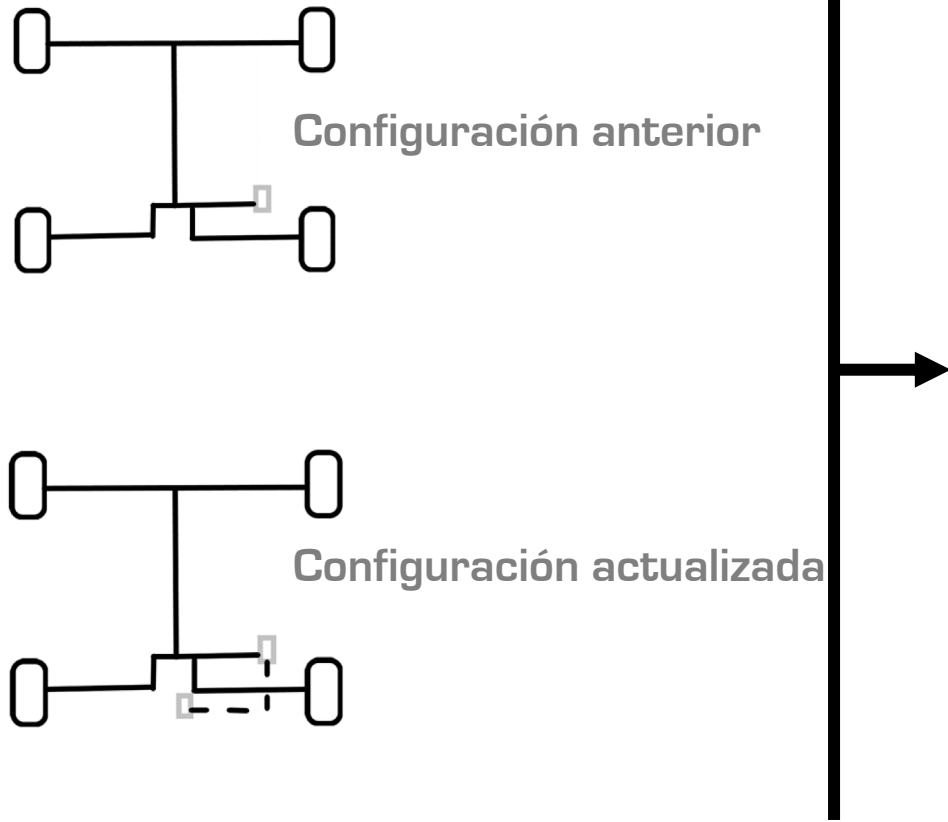



Thank you – Eskerrik Asko – Muchas Gracias